

# TORQUE AND ANGLE CONTROL SCREWDRIVERS

MD Series

---





## PRODUCTIVE SOLUTIONS

As an industrial process expert, we help you meet your challenges.

Productivity, safety, quality, industry 4.0 are themes on which we can offer you our expertise and our solutions. Whether in the field of assembly technology, machining or welding, our dedicated and specialized teams accompany your progress and recommend solutions and equipment to reach performance levels in line with your industrial strategy.



### Certified quality

From design to commissioning, DOGA guarantees the quality of this equipment and services according to ISO 9001: 2015 certification.

## 5 Reasons to trust us



### Expertise

Our Field experts propose solutions adapted to your environment and specific needs..



### Innovation

By developing the products and the services of tomorrow, we offer you new perspectives or prospects.



### Performance

Our high added value solutions improve your performance and guarantee the final quality of the production.



### Commitment

Aware of your objectives, we commit ourselves to helping you to reach them.



### Reliability

Our organization, which has been ISO 9001 certified since 1996, is the guarantee of your satisfaction.



ASSEMBLY TECHNOLOGY

As a world class assembly technology player, we manufacture and market equipment and solutions for the assembly industry which contribute to the improvement of your manufacturing quality and productivity.

Our assembly, ergonomics and traceability solutions contribute to enhancing your productivity, controlling your process quality and meeting the requirements of industry 4.0.

We offer products designed to last and high value-added services by relying on our team's know-how and expertise: design, production, installation, start-up, training and maintenance. We support you locally thanks to our worldwide presence through our subsidiaries and our specialized distribution network.



Contact us

@ international@dogas.com

+33 1 30 66 41 41

www.dogasassembly.com

# SUMMARY

## TORQUE AND ANGLE CONTROL SCREWDRIVERS

### MD Series

▶ <b>A WIDE RANGE OF ELECTRIC TOOLS WITH TORQUE AND ANGLE CONTROL</b> .....	4
Models overview.....	4
Models specifications.....	5
▶ <b>STRAIGHT SCREWDRIVERS - MD SERIES</b> .....	6
Push to start.....	6
Lever start.....	7
▶ <b>PISTOL SCREWDRIVERS - MDP SERIES</b> .....	8
Top exit cable.....	8
Bottom exit cable.....	8
▶ <b>ANGLE HEAD SCREWDRIVERS - MDH SERIES</b> .....	9
▶ <b>SPINDLE FOR AUTOMATION - MDA SERIES</b> .....	10
Without telescopic cushion .....	10
With built-in telescopic cushion .....	11
▶ <b>MDC CONTROLLERS</b> .....	12
Functionalities of the MDC V2 associated controllers.....	12
Features.....	13
Controller communication and display.....	14
Torque and angle tightening strategies .....	15
▶ <b>PROGRAMMING SOFTWARE</b> .....	18
MDC controller integrated web server .....	18
ParaMon software - free download on <a href="http://www.doga.fr">www.doga.fr</a> .....	18
▶ <b>ACCESSORIES AND SERVICES PROVIDED</b> .....	19
I/O BOX : SUB-D44 inputs / outputs wiring box.....	20
Bit holders assy.....	20
Additional side handle for pistol screwdriver.....	20
Telescopic bit cushion (TBC).....	21
Mounting ring for straight screwdrivers on reaction arm.....	21
Rotating ring for angle head nutrunners.....	21
Communication modules.....	21
RS232 barcode readers - 1D and 2D.....	22
Torque calibration service for torque and angle control tools.....	22
▶ <b>ADDITIONAL PRODUCTS</b> .....	23
Industrial bits and sockets.....	23
Bits and sockets trays.....	23
Torque reaction arms.....	24
Air vacuum kits.....	24
Screw feeders for vacuum kits or magnetized bits .....	24
ParaMon Pro X interface controller (optional) .....	26
▶ <b>OUR SERVICES</b> .....	28

# A WIDE RANGE OF ELECTRIC TOOLS WITH TORQUE AND ANGLE CONTROL



## PRODUCTIVITY

- Self-learning mode determines the best parameters to provide the best torque accuracy with the highest possible speed.
- Highest MTBF thanks to its high quality DC motor.



## MANUFACTURING QUALITY

- Extreme torque repeatability thanks to innovative shut off management (Torque rising time - Torque holding time) according to joint features.
- All errors checked thanks to Poka Yoke functions and AC/TM - TC/AM tightening strategies.

## Models overview

Among this wide range, you will find the screwdriver model and ergonomics that will allow you to optimize your workstation.



### Straight screwdrivers MD series

- From 0.03 to 49 Nm
- Lever start or push to start



### Pistol screwdrivers MDP series

- From 0.1 to 49 Nm
- Trigger start
- Bottom or top exit cable



### Angle head screwdrivers MDH series

- From 0.2 to 49 Nm



### Spindles for automation MDA series

- From 0.01 to 49 Nm
- Remote start through I/O of the controller or communication protocol

## SPECIAL MICROTORQUE

### MD Series *mini*



### Straight screwdrivers and spindles MD series mini

- From 0.01 to 0.98 Nm
- Lever start or remote start

## Models specifications

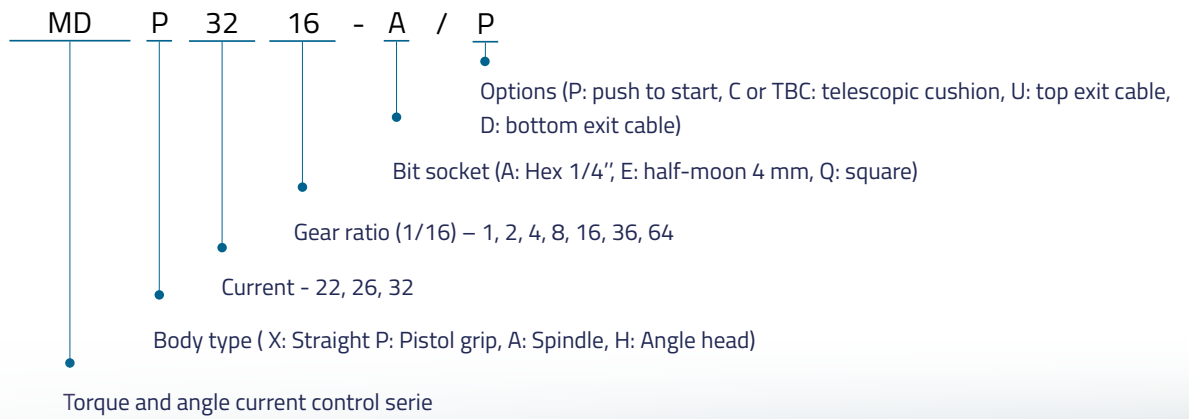

# STRAIGHT SCREWDRIVERS - MD SERIES

Compact, lightweight and ergonomic, the MD torque and angle straight screwdrivers cover a wide range of torques from 0.01 to 49 Nm.

Precise and robust, they are designed for high-speed vertical tightening operations requiring accuracy and traceability.



## Push to start

Designation	Torque (min Nm)	Torque (max Nm)	Speed (rpm)	Weight (gr)	Bit socket	Controller	Code
MD2602-A/P	0.05	0.68	150 - 2 000	435	Hex 1/4"	MDC-26	P113237
MD2602-E/P	0.05	0.68	150 - 2 000	435	Half-moon		P137289
MD2604-A/P	0.2	1.37	150 - 1 500	515	Hex 1/4"		P102914
MD2611-A/P	0.4	3.3	100 - 900	545	Hex 1/4"		P101337
MD2616-A/P	0.5	4.9	100 - 620	545	Hex 1/4"		P101281
MD3201-A/P	0.1	1.17	150 - 2 000	675	Hex 1/4"	MDC-32	P113245
MD3203-A/P	0.22	2.74	150 - 1 800	850	Hex 1/4"		P207907
MD3204-A/P	0.4	3.9	150 - 1 500	850	Hex 1/4"		P101632
MD3211-A/P	1	8.8	50 - 690	910	Hex 1/4"		P103512
MD3216-A/P	2	13.7	50 - 470	905	Hex 1/4"		P137299

*Delivered without tool cable*

## Lever start

### Mini models

Designation	Torque (min Nm)	Torque (max Nm)	Speed (rpm)	Weight (gr)	Bit socket	Controller	Code
MD2201-E mini	0.01	0.068	150 - 2 000	228	Half-moon	MDC-22	P180786
MD2203-E mini	0.04	0.196	100 - 1 000	228	Half-moon		P180787
MD2205-E mini	0.05	0.274	100 - 1 500	228	Half-moon		P180788
MD2205-A mini	0.05	0.274	100 - 1 500	228	Hex 1/4"		P205187
MD2208-E mini	0.089	0.441	100 - 950	228	Half-moon		P180789
MD2208-A mini	0.089	0.441	100 - 950	228	Hex 1/4"		P207718
MD2213-A mini	0.148	0.686	50 - 750	228	Hex 1/4"		P180790
MD2220-A mini	0.216	0.98	50 - 508	228	Hex 1/4"		P205597

Delivered without tool cable.  
M18 diameter for accessories.

### Standard models

Designation	Torque (min Nm)	Torque (max Nm)	Speed (rpm)	Weight (gr)	Bit socket	Controller	Code
MD2601-A	0.03	0.39	150 - 2 000	430	Hex 1/4"	MDC-26	P102694
MD2601-E	0.03	0.39	150 - 2 000	430	Half-moon		P109113
MD2602-A	0.05	0.68	150 - 2 000	435	Hex 1/4"		P100724
MD2602-E	0.05	0.68	150 - 2 000	435	Half-moon		P109115
MD2604-A	0.2	1.37	150 - 1 500	515	Hex 1/4"		P100308
MD2611-A	0.4	3.3	100 - 900	545	Hex 1/4"		P100082
MD2616-A	0.5	4.9	100 - 620	545	Hex 1/4"	MDC-32	P100089
MD3201-A	0.1	1.17	150 - 2 000	675	Hex 1/4"		P101026
MD3203-A	0.22	2.74	150 - 1 800	850	Hex 1/4"		P207906
MD3204-A	0.4	3.9	150 - 1 500	850	Hex 1/4"		P100196
MD3208-A	0.7	7.3	50 - 950	900	Hex 1/4"		P109159
MD3211-A	1	8.8	50 - 690	910	Hex 1/4"		P100209
MD3216-A	2	13.7	50 - 470	905	Hex 1/4"		P100342
MD3236-Q	4	27	50 - 210	1 340	SQ 3/8"		P100938
MD3264-Q	8	49	50 - 115	1 330	SQ 1/2"	P101290	

Delivered without tool cable. Square drive with pin socket retainer, square drive with ball available on request for quick change socket.

# PISTOL SCREWDRIVERS - MDP SERIES

Compact, lightweight and ergonomic, the MDP torque and angle pistol screwdrivers cover a wide range of torques from 0.1 to 49 Nm.

Ideal for horizontal tightening operations, they are accurate, robust and designed to meet your production rates and repeatability requirements.



MDP 32  
Top exit cable

## Top exit cable

Designation	Torque (min Nm)	Torque (max Nm)	Speed (rpm)	Weight (gr)	Bit socket	Controller	Code
MDP3201-A/U	0.1	1.17	150 - 2 000	735	Hex 1/4"	MDC-32	P113741
MDP3203-A/U	0.22	2.74	150 - 1 800	910	Hex 1/4"		P207908
MDP3204-A/U	0.4	3.9	150 - 1 500	910	Hex 1/4"		P101404
MDP3208-A/U	0.7	7.3	50 - 950	950	Hex 1/4"		P137303
MDP3211-A/U	1	8.8	50 - 690	970	Hex 1/4"		P103196
MDP3216-A/U	2	13.7	50 - 470	965	Hex 1/4"		P107118
MDP3236-Q/U	4	27	50 - 210	1 400	SQ 3/8		P137259
MDP3264-Q/U	8	49	50 - 115	1 410	SQ 1/2		P109123

Delivered without tool cable. Square drive with pin socket retainer, square drive with ball available on request for quick change socket.

## Bottom exit cable

Designation	Torque (min Nm)	Torque (max Nm)	Speed (rpm)	Weight (gr)	Bit socket	Controller	Code
MDP3201-A/D	0.1	1.17	150 - 2 000	735	Hex 1/4"	MDC-32	P137257
MDP3203-A/D	0.22	2.74	150 - 1 800	910	Hex 1/4"		P207909
MDP3204-A/D	0.4	3.9	150 - 1 500	910	Hex 1/4"		P102502
MDP3208-A/D	0.7	7.3	50 - 950	950	Hex 1/4"		P104364
MDP3211-A/D	1	8.8	50 - 690	970	Hex 1/4"		P107098
MDP3216-A/D	2	13.7	50 - 470	965	Hex 1/4"		P105828
MDP3236-Q/D	4	27	50 - 210	1 400	SQ 3/8		P107138
MDP3264-Q/D	8	49	50 - 115	1 410	SQ 1/2		P113761

Delivered without tool cable. Square drive with pin socket retainer, square drive with ball available on request for quick change socket.



# ANGLE HEAD SCREWDRIVERS - MDH SERIES

Compact, balanced and ergonomic, the MDH torque and angle nutrunners cover a wide range of torques from 0.2 to 49 Nm.

Their angle heads are ideal for torque and angle tightening operations in hard-to-reach areas.

They are designed to meet high production rates requiring accuracy and traceability.



MDH 26



MDH 32

Designation	Torque (min Nm)	Torque (max Nm)	Speed (rpm)	Weight (gr)	Bit socket	Controller	Code
MDH2604-A	0.2	1.37	150 - 1 500	875	Hex 1/4"	MDC-26	P103879
MDH2611-A	0.4	3.3	100 - 900	905	Hex 1/4"		P103881
MDH2616-A	0.5	4.9	100 - 620	900	Hex 1/4"		P105798
MDH3201-A	0.1	1.17	150 - 2 000	1 085	Hex 1/4"	MDC-32	P137260
MDH3203-A	0.22	2.74	150 - 1 800	1 260	Hex 1/4"		P207910
MDH3204-A	0.4	3.9	150 - 1 500	1 260	Hex 1/4"		P104938
MDH3208-A	0.7	7.3	50 - 950	1 300	Hex 1/4"		P137304
MDH3211-A	1	8.8	50 - 690	1 320	Hex 1/4"		P102018
MDH3216-A	2	13.7	50 - 470	1 315	Hex 1/4"		P101814
MDH3236-Q	4	27	50 - 210	1 940	SQ 3/8		P102310
MDH3264-Q	8	49	50 - 115	1 930	SQ 1/2		P104342

Delivered without tool cable. Square drive with pin socket retainer, square drive with ball available on request for quick change socket.

# SPINDLE FOR AUTOMATION - MDA SERIES

Compact and robust, the MDA torque and angle straight spindles cover a wide torque range from 0.01 to 49 Nm.

They are designed to be integrated into your automated systems and meet your production rates.



## Without telescopic cushion

### Mini models

Designation	Torque (min Nm)	Torque (max Nm)	Speed (rpm)	Weight (gr)	Bit socket	Controller	Code
MDA2201-E	0.01	0.68	150 - 2 000	300	Half-moon $\varnothing$ 4	MDC-22	<b>P180791</b>
MDA2203-E	0.04	0.196	100 - 1 800	300	Half-moon $\varnothing$ 4		<b>P180792</b>

Delivered without tool cable. Square drive with pin socket retainer, square drive with ball available on request for quick change socket.

### Standard models

Designation	Torque (min Nm)	Torque (max Nm)	Speed (rpm)	Weight (gr)	Bit socket	Controller	Code
MDA2601-E	0.03	0.39	150 - 2 000	525	Half-moon $\varnothing$ 4	MDC-26	<b>P109125</b>
MDA2602-E	0.05	0.68	150 - 2 000	530	Half-moon $\varnothing$ 4		<b>P137261</b>
MDA2602-A	0.05	0.68	150 - 2 000	530	Hex1/4"		<b>P104964</b>
MDA2604-A	0.2	1.37	150 - 1 500	610	Hex1/4"		<b>P104344</b>
MDA2611-A	0.4	3.3	100 - 900	640	Hex1/4"		<b>P101812</b>
MDA2616-A	0.5	4.9	100 - 620	640	Hex1/4"		<b>P113232</b>
MDA3201-A	0.1	1.17	150 - 2 000	770	Hex1/4"	MDC-32	<b>P104974</b>
MDA3203-A	0.22	2.74	150 - 1 800	945	Hex1/4"		<b>P207912</b>
MDA3204-A	0.4	3.9	150 - 1 500	945	Hex1/4"		<b>P103885</b>
MDA3208-A	0.7	7.3	50 - 950	1 000	Hex1/4"		<b>P109197</b>
MDA3211-A	1	8.8	50 - 690	1 005	Hex1/4"		<b>P101809</b>
MDA3216-A	2	13.7	50 - 470	1 000	Hex1/4"		<b>P102909</b>
MDA3236-Q	4	27	50 - 210	1 550	SQ 3/8		<b>P105852</b>
MDA3264-Q	8	49	50 - 115	1 560	SQ 1/2		<b>P137262</b>

Delivered without tool cable. Square drive with pin socket retainer, square drive with ball available on request for quick change socket.

## With built-in telescoping cushion

### Mini models

Designation	Torque (min Nm)	Torque (max Nm)	Speed (rpm)	Weight (gr)	Stroke (mm)	Bit socket	Controller	Code
MDA2201-E+C	0.01	0.068	150 - 2 000	330	10	Half-moon	MDC-22	P109244
MDA2203-E+C	0.04	0.196	100 - 1 000	330	10	Half-moon		P109246
MDA2203-A+C	0.04	0.196	100 - 1 000	330	10	Hex1/4"		P207719
MDA2205-E+C	0.05	0.274	100 - 1 500	330	10	Half-moon		P180795
MDA2205-A+C	0.05	0.274	100 - 1 500	330	10	Hex1/4"		P207721
MDA2208-E+C	0.089	0.441	100 - 950	330	10	Half-moon		P207728
MDA2208-A+C	0.089	0.441	100 - 950	330	10	Hex1/4"		P207778
MDA2213-A+C	0.148	0.686	50 - 750	330	10	Hex1/4"		P207779

Delivered without tool cable. Square drive with pin socket retainer, square drive with ball available on request for quick change socket.

### Standard models

Designation	Torque (min Nm)	Torque (max Nm)	Speed (rpm)	Weight (gr)	Stroke (mm)	Bit socket	Controller	Code
MDA3203-A/TBC	0.22	2.74	150 - 1 800	-	20	Hex1/4"	MDC-32	P207913
MDA3203-Q-TBC	0.22	2.74	150 - 1 800	-	20	SQ 3/8		P207915
MDA3204-A/TBC	0.4	3.9	150 - 1 500	-	20	Hex1/4"		P105773
MDA3211-A/TBC	1	8.8	50 - 690	-	20	Hex1/4"		P109153
MDA3216-A/TBC	2	13.7	50 - 470	-	20	Hex1/4"		P105775
MDA3236-Q/TBC	4	27	50 - 210	-	20	SQ 3/8		P104360
MDA3264-Q/TBC	8	49	50 - 115	-	20	SQ 3/8		P105779

Delivered without tool cable. Square drive with pin socket retainer, square drive with ball available on request for quick change socket.

# MDC CONTROLLERS



## Functionalities of the MDC V2 associated controllers

- Multilingual menus: German, English, Spanish, French, Czech.
- 15 tightening programs (torque and angle control).
- Choice of screwing direction of rotation for each program.
- Advanced functions with independent settings for each preset : reverse rotation, engaging torque detection, thread tapping, angle after torque-up.
- 2 multi-sequences programs, for several presets run with one cycle start.
- 15 models for multi-programs counting up to 20 customisable steps.
- Color LCD touch screen 5" with user friendly graphical interface and full tightening reporting.
- Free speed optimised according to torque (auto-speed) or manual.
- Self learning mode for tightening parameters optimization.
- Detailed alarm display with error code.
- Integrated web server for parameters set up with a standard web browser.
- Free PC software for programming and real time monitoring called ParaMon.
- Tightening curve display in real time.
- Real time fastening data output.
- RS232 and Ethernet communication ports, Modbus protocols or Open Protocol.
- Program calls via barcode reader (RS232).
- Standard SD card and drive for saving parameters and screwing programs, screwing reports and controller firmware updates.
- Assignable digital 15 inputs / 8 outputs.
- ESD Free by body grounding
- Increased durability (> 5 millions cycles).

## Specifications

<b>Voltage</b>	Input: AC 230 V, 50/60Hz, 2.5 A / Output: DC 38 V 3.5 A
<b>Fuse</b>	2 x T5 A / 230 V
<b>Operating environment</b>	0 ~ 40°C / 15 ~ 80% RH (without dew)
<b>Front panel</b>	5" LCD color 800 x 480 dots – touch & multilingual menus
<b>Inputs/Outputs</b>	8 inputs and 8 outputs assignable + 7 free inputs assigned to models via SUB-D25 port
<b>SD card</b>	Included one 8 GB SD card - industrial grade
<b>Dimensions and weight</b>	MDC-20: W 145 x H 110 x D 70 mm – 1.2 kg MDC-26 et MDC-32: W 146 x H 114 x D 203 mm – 2.5 kg

## Software

<b>Management of firmware update</b>	Via SD card
<b>Firmwares</b>	Controller main board / LCD display
<b>Language</b>	French, English, German, Spanish, Czech
<b>Parameter settings</b>	Via controller front LCD / Web Server / ParaMon software
<b>Protocols</b>	Modbus, Open Protocol
<b>Models</b>	15 models consisting of 20 steps each
<b>Tightening presets</b>	15 programs consisting of 15 keys parameters each
<b>Advanced functions</b>	4 functions for each programs: free reverse rotation, engaging torque detection, thread tapping, angle after torque up

## Controllers

Designation	Suitable for	Code
MDC-22 AC 230 V CE	MD22xx, MDA22xx	<b>P116806</b>
MDC-26 AC 230 V CE	MD26xx, MDH26xx, MDA26xx	<b>P100015</b>
MDC-32 AC 230 V CE	MD32xx, MDP32xx, MDH32xx, MDA32xx	<b>P100009</b>

## Options

Designation	Code	Designation	Code
RS232 DB9 male / female cable 3 m	<b>P101542</b>	Lift up stand kit	<b>P100971</b>
RS232 / USB converter	<b>P101402</b>	Industrial SD card 8 GB	<b>P104277</b>

# Controller communication and display

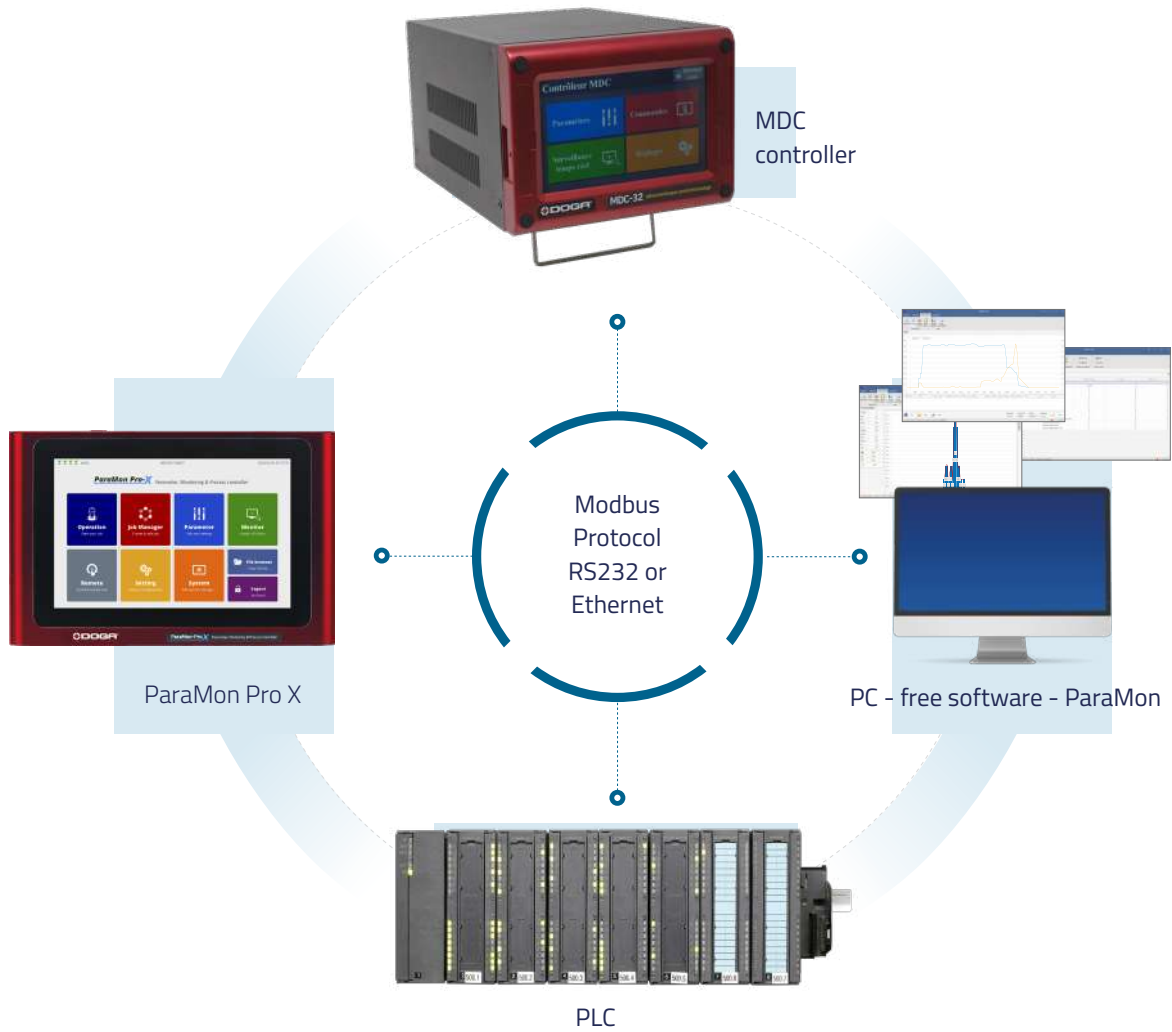

Menu

Date and time

Torque target

Speed target/Monitoring

Time

Monitoring angle

Count target/Monitoring

Snug angle

Program - Preset (1 to 15)

Fastening result OK/NOK

Monitoring torque

# Torque and angle tightening strategies

15 different tightening programs can be set in each MDC controller. Each program can be set with 15 customizable parameters. Tightening direction may be different for each preset.

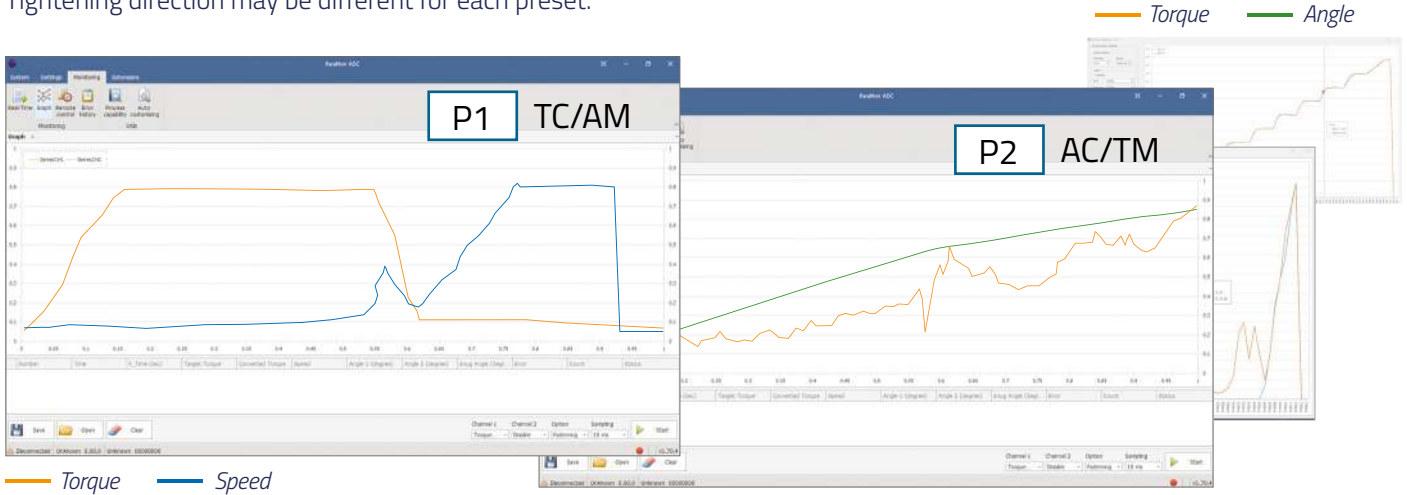

## Each preset program has the following customized parameters

- ▶ Tightening mode
  - Torque control + angle monitoring TC / AM
  - Angle control + torque monitoring AC / TM
- ▶ Torque
  - Target torque, min/max torque, snug torque, seating torque, torque compensation
- ▶ Angle
  - Target angle, min/max angle, free speed angle
- ▶ Speed
  - Target speed, free speed
- ▶ Time
  - Soft start time, torque rising time, torque holding time

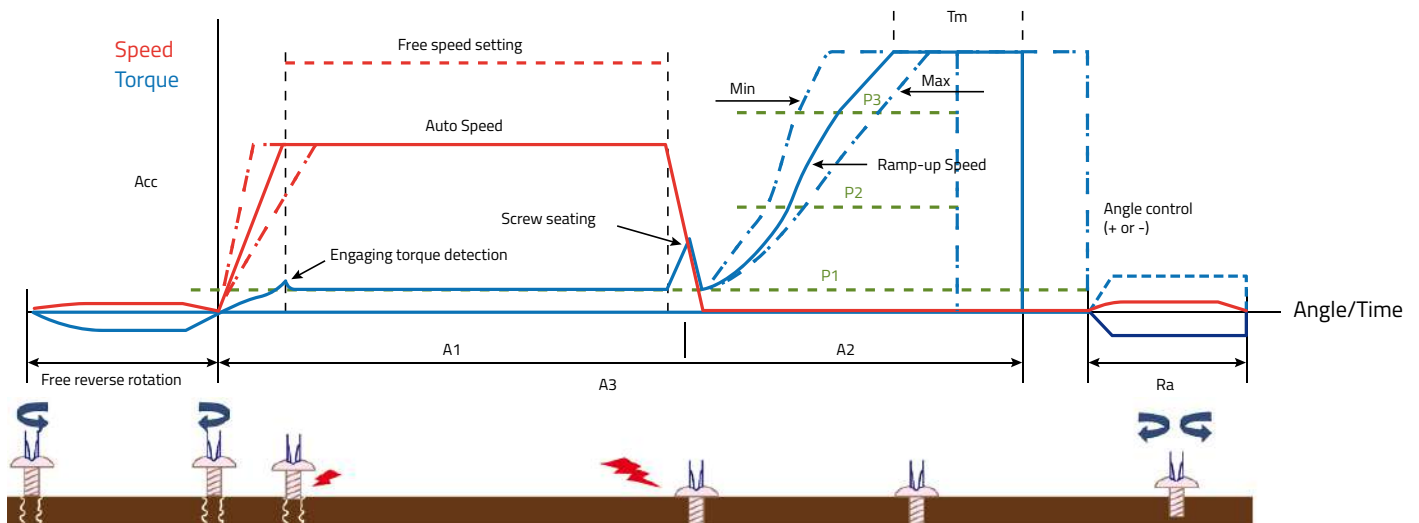

## MA and MB multisequences programs

- MA and MB allow to chain several programs in a single cycle with a maintained trigger.
- A multisequence can be made up of 10 steps.
- A step is either a program, a loosening or a delay and can be repeated several times.

Example: achieving capability on a test bench.



## Easy guidance to the optimized tightening conditions by built-in self customizing simulation feature

Self customizing software will find the optimized parameters to provide torque accuracy for the target torque in fastest speed. Just run tightenings with factory settings until the software stop adjusting parameter settings.

- Optimized speed according to the target torque level.
- Free angle and free speed calculation for fast run down.
- Seating point adjustment.

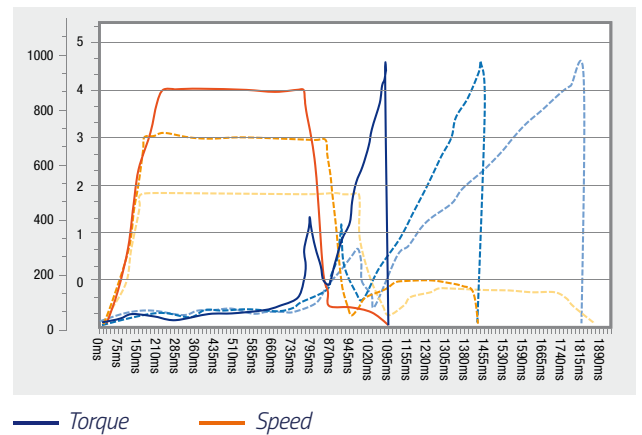

## Advanced functions

Consist of 4 usefull advanced functions.

All functions can be set with different parameters for each program.

They meet specific needs such as:

Free reverse rotation to engage screw	Thread tapping to overcome a thread torque higher than target torque	Engaging torque detection to detect a lock nut	Angle after torque up to go reverse for inserts fitting



# Models

- With models you can apply Sequence control by managing tightening preset#, screw counting, time delay, inputs & outputs which provide automation without PLC or sequence control device.
- 15 process sequence managing models. Each model consisting with 20 steps of sequence program.
- Each step can control:
  - A tightening batch (TC/AM or AC/TM) with a counter of OK results.
  - An output activation.
  - An Input monitoring.
  - A time delay.
  - A bar code reading.
- A report « model complete » validates the end of the model (sequence end).



## Sample program of sequence control

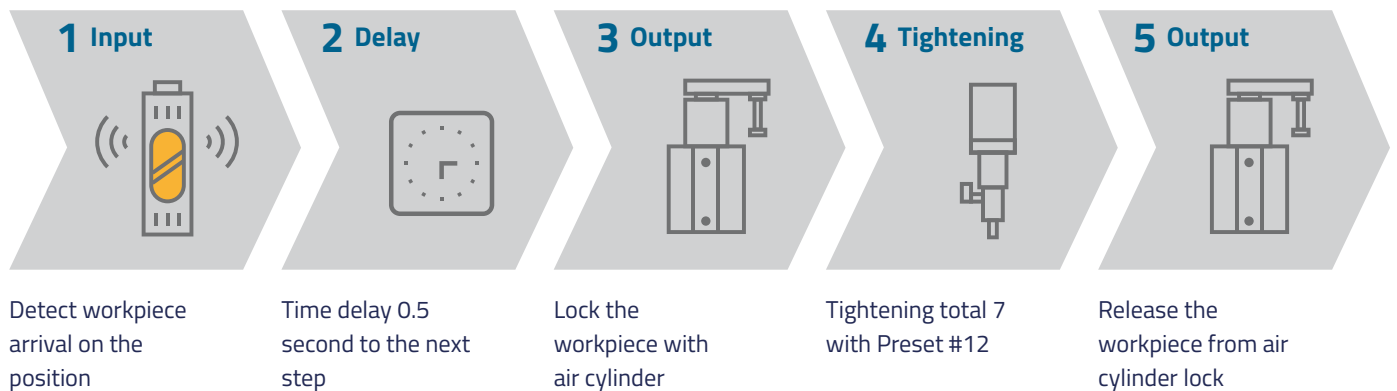

# Modbus protocol communication

MDC controller provides the Modbus RTU for RS232 and Modbus TCP/IP for the Ethernet port connection together. The following is available through the communication:

- Parameter read and write
- Data monitoring
- Remote control operation

### Modbus RTU

Slave ID	F code	Data	CRC
----------	--------	------	-----

### Modbus TCP

Transaction ID	Protocol ID	Length	Unit ID	F code	Data
----------------	-------------	--------	---------	--------	------

# PROGRAMMING SOFTWARE

## MDC controller integrated web server

Without any software preinstalled on your computer access to your MDC controller connected via Ethernet by using your web browser. Just enter the MDC IP address of each controller in a navigation tab. All functions for parameters setting, saving and monitoring are available.



## ParaMon software - free download on [www.doga.fr](http://www.doga.fr)

With Ethernet or RS232 connection, free PC software ParaMon provides easy parameters setting, data monitoring & analysis. Several windows can be opened at same time to display and edit settings simultaneously. Multi-channel graph (torque, angle, speed, time) allow a precise analysis of your assembly and settings optimization. Tightening curves and results can be monitored in real time and saved for later offline viewing.

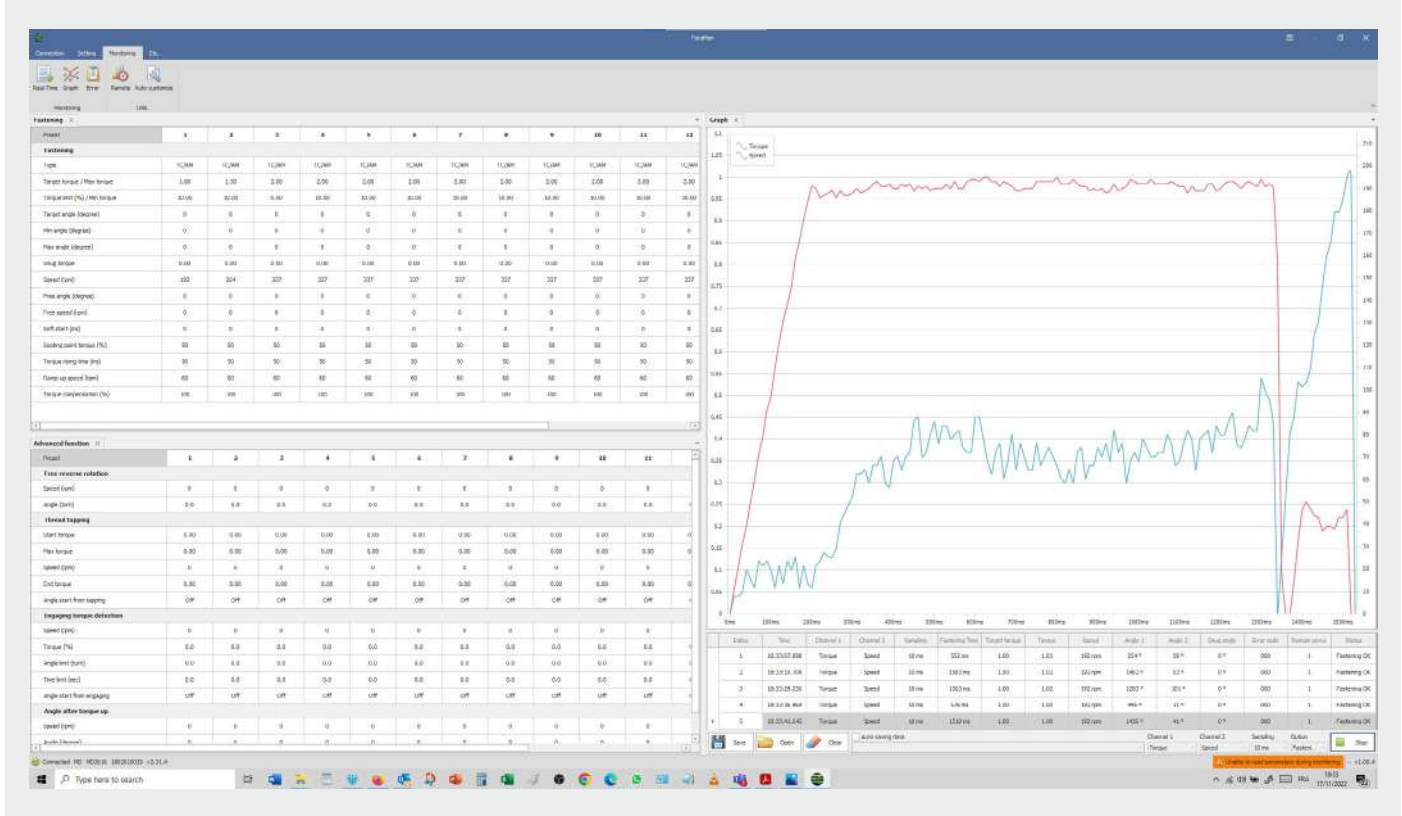

# ACCESSORIES AND SERVICES PROVIDED

## MD screwdrivers cables

### Cables for MD 22 mini screwdrivers

Designation	Code
MD mini cable 3 m	<b>P103859</b>
MD mini cable 5 m	<b>P137302</b>



### Standard cables for MD26 / MD32 models

Designation	Code
MD cable 3 m	<b>P100003</b>
MD cable 5 m	<b>P100208</b>
MD cable 8 m	<b>P102905</b>



Screwdriver max torque can be lowered by 5% and 20% with extra long 5 and 8 meters cables.

### Reinforced cables for MD26 / MD32 models

Reinforced cables are highly recommended for angle and pistol screwdrivers applications.

Designation	Code
MD Reinforced cable II 3 m	<b>P100048</b>
MD Reinforced cable II MD 5 m	<b>P100229</b>
MD Reinforced cable II MD 8 m	<b>P101887</b>



Screwdriver max torque can be lowered by 5% and 20% with extra long 5 and 8 meters cables.



### Special connectors for MD26 / MD32 cables

Designation	Code
90° connector length 70 mm rotatable by 180°	<b>P103856</b>
Cable extension connector M/M	<b>P113331</b>



Extension connector

Rotatable by 180°

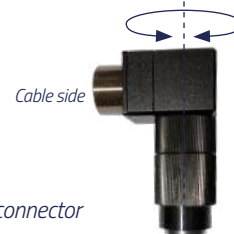

90° connector

Screwdriver side

### I/O cable

Designation	Code
DB25 cable 3M Uncabled	<b>P100278</b>



## I/O BOX : SUB-D44 inputs / outputs wiring box

For easy wiring of the 8 inputs / 8 outputs of the MDC controller by sharing a single 24 V power supply. Output port has the relay contact with the max. 1 A capacity for each port.

Be sure that de 24 V DC power supply should have enough capacity for total output load.

Designation	Code
44 P I/O box	<b>P101234</b>
I/O cable / MDC	<b>P101400</b>
24 V supply	<b>P101338</b>

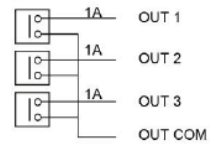

The 7 inputs of the MDC V2 dedicated to models cannot be connected to I/O box.

## Bit holders assy

Extra bit holders with bearing provide better bit concentricity.



Designation	Suitable for	Bit socket	Bit lenght	Code
Bit holder assy ø 4 mm M16	MD2201, MD2203-E (older models in M16)	Ø 4 mm	44 mm	<b>P113446</b>
Bit holder assy ø 4 mm M18	MD22xx-M18, MDA22xx-M18	Ø 4 mm	44 mm	<b>P180481</b>
Bit holder assy ø 4 mm M20	MD26xx-E	Ø 4 mm	64 mm	<b>P137286</b>
Bit holder assy ø 7 mm M20	MD26xx-A, MD3201-A, MD3202-A	Ø 7 mm	70 mm	<b>P105000</b>
Bit holder assy Hex 1/4" M20		Hex 1/4 "	70 mm	<b>P113475</b>
Bit holder assy ø 7 mm M23	MD3204 to MD3216	Ø 7 mm	70 mm	<b>P101398</b>
Bit holder assy Hex 1/4" M23		Hex 1/4 "	70 mm	<b>P137355</b>

## Additional side handle for pistol screwdriver

Designation	Suitable for	Code
Side handle for torque recovery - Ø 41	MDP3204 ~ 3216	<b>P104374</b>



## Telescopic bit cushion (TBC)

Designation	Suitable for	Code
MDA telescopic bit cushion half moon [TBC 2601-02-E] - 20 mm	MDA2601 MDA2602	<b>P207715</b>
MDA telescopic bit cushion Hex 1/4" [TBC 3204-16-A] - 20 mm	MDA3204, MDA3211 MDA3216	<b>P113233</b>
MDA telescopic bit cushion Hex 1/4" [TBC 3204-16-A] - 50 mm	MDA3204, MDA3211 MDA3216	<b>P207883</b>
MDA telescopic bit cushion SQ 3/8" [TBC 3236-64-Q] - 20 mm	MDA3236 MDA3264	<b>P113235</b>

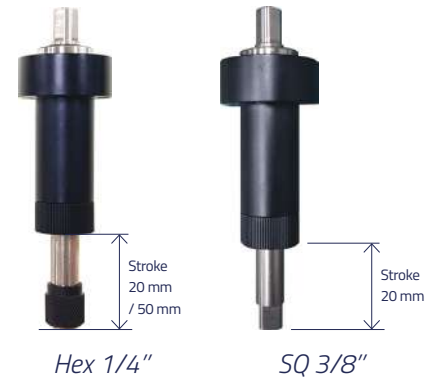

## Mounting ring for straight screwdrivers on reaction arm

Anodized aluminium ring for mounting a straight screwdriver on a reaction arm.

Designation	Suitable for	Code
Ring Ø 36	MD2601 ~ 16	<b>P104351</b>
Ring Ø 41	MD3201 ~ 16	<b>P109230</b>
Ring Ø 43	MD3236 ~ 64	<b>P113743</b>



## Rotating ring for angle head nutrunners

Made of anodized aluminium with adjustable center of gravity.  
Easy rotation thanks to the ball bearing assembly.  
Balancer and snap hook are not included.

Designation	Suitable for	Code
Rotating ring Ø 41	MDH3204 ~ 3216	<b>P136950</b>
Rotating ring Ø 43	MDH3236 ~ 3264	<b>P136951</b>



## Communication modules

Designation	Code
Communication module Modbus TCP to Profinet	<b>P113165</b>
Communication module Modbus TCP to Ethernet IP	<b>P117308</b>
Communication module settings	<b>P179414</b>

*Other protocols on request. Wi-Fi access point not included.*



## RS232 barcode readers - 1D and 2D

To select preset or model.

Barcode is merged to tightening datas on SD memory card or read over Modbus protocol.

Designation	Specification	Code	
Wired scanner kit 1D / 2D RS232 DS2208 Type	Scanner type DS2208 for 1D and 2D barcode reading. 2 m USB straight cable, 2 m DB19 RS232 straight cable, 5,2 V power supply for RS232 cable, MDC null modem adapter, M / M MDC gender changer, holder, reading distance from 1 to 35 cm, optical sensor resolution 640 pixels, reading on paper or screen, IP 42, color black	P180776	
Wireless scanner kit 1D / 2D RS232 DS2278 Type	Scanner type DS2278 for 1D and 2D barcode reading. Bluetooth wireless (max. range 100 m), charging station / holder, 2 m USB straight cable, 2 m DB19 RS232 straight cable, MDC null modem adapter, M / M MDC gender changer, reading distance from 1 to 35 cm, optical sensor resolution 640 pixels, reading on paper or screen, IP 52, color black	P180777	
Wired scanner kit 1D / 2D RS232 DS3608 Type	Scanner type DS3608 for 1D et 2D barcode reading. Programmable and intelligent, 2 m DB19 RS232 straight cable, 12 V power supply for RS232 cable, MDC null modem adapter, M / M MDC gender changer, holder, reading distance from 1 to 150 cm, optical sensor resolution 1280 pixels, reading on paper or screen, IP 67, color black / green	P180780	
Wireless scanner kit 1D / 2D RS232 DS3678 Type	Scanner type DS3678 for 1D and 2D barcode reading. Programmable and intelligent, Bluetooth wireless (max. range 100 m), charging station / holder, 2 m USB straight cable, 2 m DB19 RS232 straight cable, MDC null modem adapter, M / M MDC gender changer, reading distance from 1 to 150 cm, optical sensor resolution 1280 pixels, reading on paper or screen IP 7, color black / green	P180781	



Adapter and gender charger essential for connecting the scanner.



All scanners can read barcodes as well as 2D codes



No : 12345678900000000000

## Torque calibration service for torque and angle control tools

Service provided on our premises.

- Machine capability test  $C_m / C_{mk} > 1.67$  with a tolerance of +/- 10% on the delivered torque.
- Calculation of the measurements average, standard deviation and machine capability  $C_m / C_{mk}$  on 25 measurements.
- Adjustment of the screwdriver calibration and / or torque compensation if needed.
- Test report.

Designation	Code
Machine capability report for 1 torque value (by default 80% of max torque)	P179405
Machine capability report for 3 torque values (20%, 50%, 100% of max torque)	P179454

# ADDITIONAL PRODUCTS

## Industrial bits and sockets



### A wide range of industrial bits and impact sockets adapted to all your needs

Wherever they are screwed, screws and nuts of all shapes and materials can be matched with their sockets and bits hexagonal or square.

Forged from the best steels and regularly checked, they offer constant quality.

- More than 600 references of industrial bits managed in stock
- Creation of tailor-made bits and impact sockets
- Sockets available as standard or 1/4" to 2 1/2" drive squares

> Learn more  
about our  
industrial bits



> Learn more  
about our  
impact sockets



## Bits and sockets trays

Reduce errors in your screwing processes and improve your productivity

BS-5C COLOR ID



BST-LCD



BST 8W LCD WI-FI



ST-4 LCD



We offer a complete range of bit trays and socket trays, specially designed to eliminate incorrect program selection with the selected bit or socket.

You can link each bit or socket with a tightening program and vice versa depending on the operating mode.

They prevent errors by locking the screwdrivers.

This simplifies workstation operation considerably.

By using our bit and socket trays, you can be sure of getting the job done perfectly.

A real innovation recognized in many activities: automotive, aviation, medicine, etc.

> To learn more about our bits and sockets trays,  
see the documentation DOC.60314



## Torque reaction arms



### Improve your operators' comfort (elimination of MSD), the quality of your assemblies and your productivity

To guarantee optimal quality and traceability, most DOGA torque reaction arms are available with a positioning system.

So every screw is tightened at the right location and at the right torque!

> Learn more about our torque reaction arms



## Air vacuum kits



### Discover our screw gripping system for your assembly tools

The assembly of non-magnetic or small screws is delicate or even difficult when access to the screwing point is restricted.

Air vacuum kits, holding the screw by vacuum at the end of the screwdriver, make it possible to:

- Free up the operator's hand and make it easier to assemble your application
- Reach screwing points that are difficult to access (shafts, small space, etc.)
- Avoid unexpected fall of screw into your products

> Learn more about our air vacuum kits

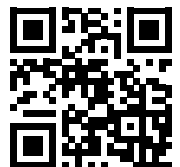

## Screw feeders for vacuum kits or magnetized bits



### Choose our automatic or semi-automatic screw feeding systems

In addition to our vacuum kits, our screw feeding systems reduce operator cycle times and maintain their comfort.

- The screws can be picked by vacuum or magnets
- Simple and efficient design
- No more screws falling out of your products
- Smooth and uninterrupted screw delivery
- Can be integrated into automatic machines

> Learn more about our screw feeders





# DPC Touch V2 sequencing interface



## Compatible with most assembly tools (up to 2 screwdrivers)

The sequencing and assembly process monitoring interface DPC Touch can count, control, order and check assembly steps and adapts perfectly to all your applications.

It can be installed on stand-alone workstations or within a production line.

DPC Touch manages our range of torque reaction arms to control the order in which screws are fitted.

It guarantees you optimum quality and traceability for zero-defect assembly.

> Watch  
our demonstration  
video



> Learn more about our DPC Touch V2 sequencing interface



## ParaMon Pro X interface controller (optional)



### Features

- Total 8 tools can be connected, MD / MDT or BM / BMT series (battery version).
- Management of parameters and programs for all connected screwdrivers.
- Data monitoring (visualization of graphs and results).
- Creation of screwing jobs (Job manager) : product assembly quality control with tightening strategies, batch counting, assembly visualization, I/O logic management and operator assistance.
- Tool remote control.
- Fastening data auto saving with file system.

### Specifications

<b>Input power</b>	AC 220 - 240 V, 50/60 Hz, 0.35 A
<b>Dimensions (WxHxD)</b>	300 (W) x 196 (H) x 80 (D) mm - Wall mount bracket included
<b>Display</b>	10,1" TFT LCD touch
<b>Communication ports</b>	Ethernet, 4 x USB, barcodes reader, I/O (16 TOR inputs, 16 TOR outputs), RS232
<b>Memory</b>	Internal memory : 16 Go + slot for micro SD card up to 32 Go (micro SD card not included)
<b>Wi-Fi</b>	USB 2.4 & 5 Ghz dual-band Wi-Fi key (external)
<b>Display extension</b>	HDMI
<b>Weight</b>	3.54 kg

Designation

ParaMon Pro X V3 controller

Code

**P102478**

# Operation mode with Job versus multi-screwdrivers mode

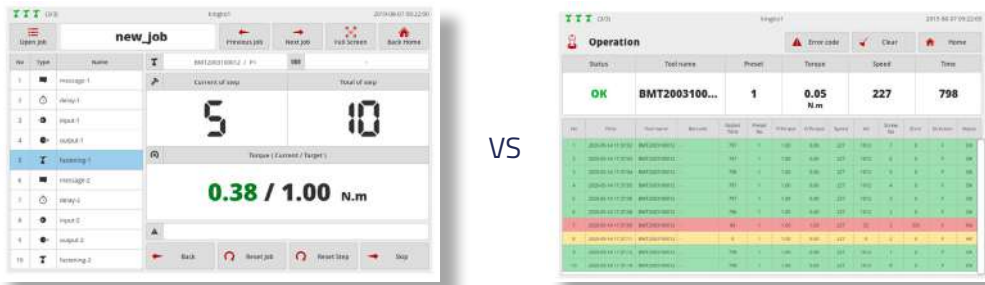

VS

Operation mode	Job Manager (sequencing mode with logical steps)	Multi-screwdrivers (Multi-tool tightening mode)
Features	<ul style="list-style-type: none"> <li>5 types of steps (fastening / input / output / delay / message) are provided for sequence programming.</li> <li>Interactive photo management with overlay of screwdriving points.</li> <li>The combination of steps is called a job.</li> <li>Up to 1 000 jobs are supported.</li> <li>Fastening data is auto saved in the file system.</li> <li>Job pause and resume modes.</li> <li>Additional screwdriving programs available.</li> </ul>	<ul style="list-style-type: none"> <li>Not support process control.</li> <li>Display fastening data receiving from tools in real-time.</li> <li>Fastening data is auto saved in the file system.</li> </ul>
Screwdrivers	<ul style="list-style-type: none"> <li>The tool works only in the fastening step.</li> <li>In the fastening step, only one tool can be assigned.</li> <li>Two or more tools cannot work simultaneously.</li> <li>Suitable for single operator environments.</li> </ul>	<ul style="list-style-type: none"> <li>No restriction on the use of the tool.</li> <li>All tools can work simultaneously.</li> <li>Suitable for multiple operator environments.</li> </ul>
Barcode scanner	<ul style="list-style-type: none"> <li>To load the desired job by scanning barcode.</li> <li>Components traceability.</li> </ul>	<ul style="list-style-type: none"> <li>To select the preset torque on the tools.</li> </ul>

## Sample Job

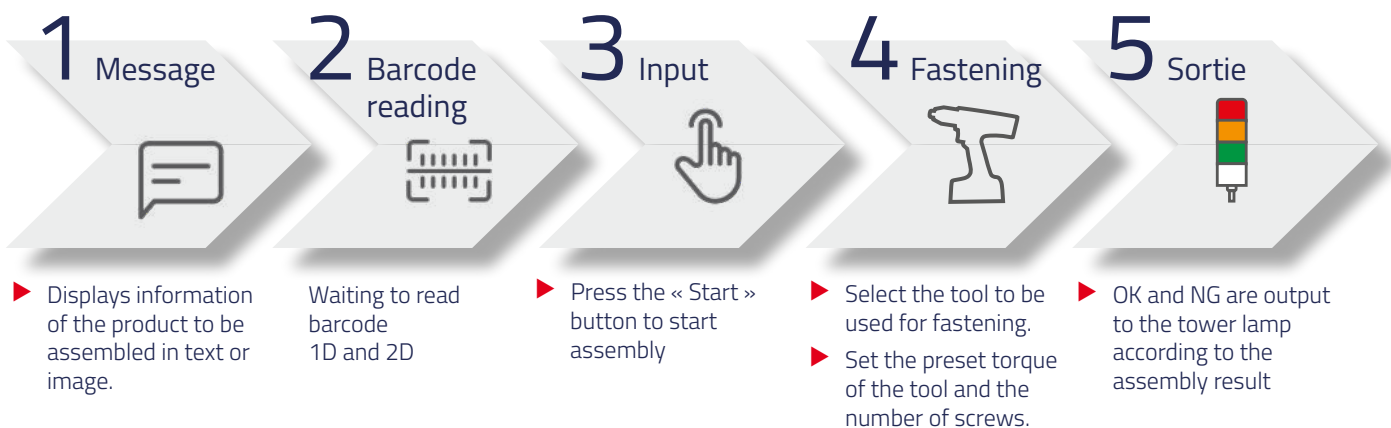

# OUR SERVICES

At DOGA we put at your disposal our reliable, accurate and user-friendly tightening solutions. It is our duty to advise you of the right solution for your application. Our Product Manager and Support engineering teams are here to analyze your manufacturing process and share with you our innovative solutions to improve your assembly process. Thanks to our technical integration service CELPRO, we provide you with turnkey solutions from design to commissioning.



## TURNKEY SOLUTIONS

Using all the options of our complete product range, we offer you solutions adapted to your needs.

- ▶ Custom Design
- ▶ Adaptation of existing models
- ▶ Integration of automation system



## TECHNICAL ASSISTANCE

To ensure the optimal performance and durability of our tools, we put our technical assistance at your disposal.

- ▶ Installation and start-up
- ▶ Maintenance agreement
- ▶ On-site maintenance
- ▶ Maintenance in our workshop



## TRAINING

DOGA offers specialized training courses for our industries:

- ▶ Technical & practical
- ▶ Audit & Consulting

Find all our ASSEMBLY TECHNOLOGY products on our website by scanning this QR code

